

CONTACTOR, AC-3, 7.5KW/400V, 1NO+1NC, DC 24V, COM.  
CAPABILITY, 3-POLE, SZ S0 SCREW TERMINAL



product brandname	SIRIUS
Product designation	Power contactor
Product type designation	3RT2
<b>General technical data</b>	
Size of contactor	S0
Product extension	
• function module for communication	Yes
• Auxiliary switch	Yes
Insulation voltage	
• rated value	690 V
Surge voltage resistance rated value	6 kV
maximum permissible voltage for safe isolation	
• between coil and main contacts acc. to EN 60947-1	400 V
Protection class IP	
• on the front	IP20
• of the terminal	IP20
Shock resistance at rectangular impulse	
• at DC	10g / 5 ms, 7,5g / 10 ms

<b>Shock resistance with sine pulse</b>	
<ul style="list-style-type: none"> <li>• at DC</li> </ul>	15g / 5 ms, 10g / 10 ms
<b>Mechanical service life (switching cycles)</b>	
<ul style="list-style-type: none"> <li>• of contactor typical</li> </ul>	10 000 000
<ul style="list-style-type: none"> <li>• of the contactor with added electronics-compatible auxiliary switch block typical</li> </ul>	5 000 000
<ul style="list-style-type: none"> <li>• of the contactor with added auxiliary switch block typical</li> </ul>	10 000 000

### Ambient conditions

<b>Ambient temperature</b>	
<ul style="list-style-type: none"> <li>• during operation</li> </ul>	-25 ... +60 °C
<ul style="list-style-type: none"> <li>• during storage</li> </ul>	-55 ... +80 °C

### Main circuit

<b>Number of poles for main current circuit</b>	3
<b>Number of NO contacts for main contacts</b>	3
<b>Operating voltage</b>	
<ul style="list-style-type: none"> <li>• at AC-3 rated value maximum</li> </ul>	690 V
<b>Operating current</b>	
<ul style="list-style-type: none"> <li>• at AC-1 at 400 V <ul style="list-style-type: none"> <li>— at ambient temperature 40 °C rated value</li> </ul> </li> </ul>	40 A
<ul style="list-style-type: none"> <li>• at AC-1 <ul style="list-style-type: none"> <li>— up to 690 V at ambient temperature 40 °C rated value</li> </ul> </li> </ul>	40 A
<ul style="list-style-type: none"> <li>— up to 690 V at ambient temperature 60 °C rated value</li> </ul>	35 A
<ul style="list-style-type: none"> <li>• at AC-2 at 400 V rated value</li> </ul>	17 A
<ul style="list-style-type: none"> <li>• at AC-3 <ul style="list-style-type: none"> <li>— at 400 V rated value</li> </ul> </li> </ul>	17 A
<ul style="list-style-type: none"> <li>— at 500 V rated value</li> </ul>	17 A
<ul style="list-style-type: none"> <li>— at 690 V rated value</li> </ul>	13 A
<b>Connectable conductor cross-section in main circuit at AC-1</b>	
<ul style="list-style-type: none"> <li>• at 60 °C minimum permissible</li> </ul>	10 mm <sup>2</sup>
<ul style="list-style-type: none"> <li>• at 40 °C minimum permissible</li> </ul>	10 mm <sup>2</sup>
<b>Operating current for approx. 200000 operating cycles at AC-4</b>	
<ul style="list-style-type: none"> <li>• at 400 V rated value</li> </ul>	7.7 A
<ul style="list-style-type: none"> <li>• at 690 V rated value</li> </ul>	7.7 A
<b>Operating current</b>	
<ul style="list-style-type: none"> <li>• at 1 current path at DC-1 <ul style="list-style-type: none"> <li>— at 24 V rated value</li> </ul> </li> </ul>	35 A
<ul style="list-style-type: none"> <li>— at 110 V rated value</li> </ul>	4.5 A

— at 220 V rated value	1 A
— at 440 V rated value	0.4 A
— at 600 V rated value	0.25 A
• with 2 current paths in series at DC-1	
— at 24 V rated value	35 A
— at 110 V rated value	35 A
— at 220 V rated value	5 A
— at 440 V rated value	1 A
— at 600 V rated value	0.8 A
• with 3 current paths in series at DC-1	
— at 24 V rated value	35 A
— at 110 V rated value	35 A
— at 220 V rated value	35 A
— at 440 V rated value	2.9 A
— at 600 V rated value	1.4 A
<b>Operating current</b>	
• at 1 current path at DC-3 at DC-5	
— at 24 V rated value	20 A
— at 110 V rated value	2.5 A
— at 220 V rated value	1 A
— at 440 V rated value	0.09 A
— at 600 V rated value	0.06 A
• with 2 current paths in series at DC-3 at DC-5	
— at 24 V rated value	35 A
— at 110 V rated value	15 A
— at 220 V rated value	3 A
— at 440 V rated value	0.27 A
— at 600 V rated value	0.16 A
• with 3 current paths in series at DC-3 at DC-5	
— at 24 V rated value	35 A
— at 110 V rated value	35 A
— at 220 V rated value	10 A
— at 440 V rated value	0.6 A
— at 600 V rated value	0.6 A
<b>Operating power</b>	
• at AC-1	
— at 230 V rated value	13.3 kW
— at 230 V at 60 °C rated value	13.3 kW
— at 400 V rated value	23 kW
— at 400 V at 60 °C rated value	23 kW
— at 690 V rated value	40 kW

<ul style="list-style-type: none"> <li>— at 690 V at 60 °C rated value</li> </ul>	40 kW
<ul style="list-style-type: none"> <li>• at AC-2 at 400 V rated value</li> </ul>	7.5 kW
<ul style="list-style-type: none"> <li>• <b>at AC-3</b> <ul style="list-style-type: none"> <li>— at 230 V rated value</li> <li>— at 400 V rated value</li> <li>— at 690 V rated value</li> </ul> </li> </ul>	4 kW 7.5 kW 11 kW
<b>Operating power for approx. 200000 operating cycles at AC-4</b>	
<ul style="list-style-type: none"> <li>• at 400 V rated value</li> </ul>	3.5 kW
<ul style="list-style-type: none"> <li>• at 690 V rated value</li> </ul>	6 kW
<b>Thermal short-time current limited to 10 s</b>	150 A
<b>Power loss [W] at AC-3 at 400 V for rated value of the operating current per conductor</b>	0.9 W
<b>No-load switching frequency</b>	
<ul style="list-style-type: none"> <li>• at DC</li> </ul>	1 500 1/h
<b>Operating frequency</b>	
<ul style="list-style-type: none"> <li>• at AC-1 maximum</li> </ul>	1 000 1/h
<ul style="list-style-type: none"> <li>• at AC-2 maximum</li> </ul>	1 000 1/h
<ul style="list-style-type: none"> <li>• at AC-3 maximum</li> </ul>	1 000 1/h
<ul style="list-style-type: none"> <li>• at AC-4 maximum</li> </ul>	300 1/h

Control circuit/ Control	
<b>Type of voltage of the control supply voltage</b>	DC
<b>Control supply voltage at DC</b>	
<ul style="list-style-type: none"> <li>• rated value</li> </ul>	24 V
<b>Closing power of magnet coil at DC</b>	5.9 W
<b>Holding power of magnet coil at DC</b>	5.9 W
<b>Closing delay</b>	
<ul style="list-style-type: none"> <li>• at DC</li> </ul>	50 ... 170 ms
<b>Opening delay</b>	
<ul style="list-style-type: none"> <li>• at DC</li> </ul>	15 ... 17.5 ms
<b>Arcing time</b>	10 ... 10 ms
<b>Residual current of the electronics for control with signal &lt;0&gt;</b>	
<ul style="list-style-type: none"> <li>• at AC at 230 V maximum permissible</li> </ul>	6 mA
<ul style="list-style-type: none"> <li>• at DC at 24 V maximum permissible</li> </ul>	16 mA

Auxiliary circuit	
<b>Number of NC contacts</b>	
<ul style="list-style-type: none"> <li>• for auxiliary contacts <ul style="list-style-type: none"> <li>— instantaneous contact</li> </ul> </li> </ul>	1
<b>Number of NO contacts</b>	
<ul style="list-style-type: none"> <li>• for auxiliary contacts <ul style="list-style-type: none"> <li>— instantaneous contact</li> </ul> </li> </ul>	1

Operating current at AC-12 maximum	10 A
<b>Operating current at AC-15</b>	
• at 230 V rated value	10 A
• at 400 V rated value	3 A
• at 500 V rated value	2 A
• at 690 V rated value	1 A
<b>Operating current at DC-12</b>	
• at 24 V rated value	10 A
• at 48 V rated value	6 A
• at 60 V rated value	6 A
• at 110 V rated value	3 A
• at 125 V rated value	2 A
• at 220 V rated value	1 A
• at 600 V rated value	0.15 A
<b>Operating current at DC-13</b>	
• at 24 V rated value	10 A
• at 48 V rated value	2 A
• at 60 V rated value	2 A
• at 110 V rated value	1 A
• at 125 V rated value	0.9 A
• at 220 V rated value	0.3 A
• at 600 V rated value	0.1 A
<b>Contact reliability of auxiliary contacts</b>	1 faulty switching per 100 million (17 V, 1 mA)

#### UL/CSA ratings

<b>Full-load current (FLA) for three-phase AC motor</b>	
• at 480 V rated value	14 A
• at 600 V rated value	17 A
<b>Yielded mechanical performance [hp]</b>	
• for single-phase AC motor	
— at 110/120 V rated value	1 hp
— at 230 V rated value	3 hp
• for three-phase AC motor	
— at 200/208 V rated value	3 hp
— at 220/230 V rated value	5 hp
— at 460/480 V rated value	10 hp
— at 575/600 V rated value	15 hp
<b>Contact rating of auxiliary contacts according to UL</b>	A600 / Q600

#### Short-circuit protection

<b>Design of the fuse link</b>	
• for short-circuit protection of the main circuit	
— with type of coordination 1 required	gG NH 3NA, DIAZED 5SB, NEOZED 5SE: 63 A

- with type of assignment 2 required
- for short-circuit protection of the auxiliary switch required

gG NH 3NA, DIAZED 5SB, NEOZED 5SE: 25 A  
fuse gG: 10 A

### Installation/ mounting/ dimensions

<b>Mounting position</b>	+/-180° rotation possible on vertical mounting surface; can be tilted forward and backward by +/- 22.5° on vertical mounting surface
<b>Mounting type</b>	screw and snap-on mounting onto 35 mm standard mounting rail according to DIN EN 60715
<ul style="list-style-type: none"> <li>• Side-by-side mounting</li> </ul>	Yes
<b>Height</b>	85 mm
<b>Width</b>	45 mm
<b>Depth</b>	107 mm
<b>Required spacing</b>	
<ul style="list-style-type: none"> <li>• for grounded parts <ul style="list-style-type: none"> <li>— at the side</li> </ul> </li> <li>• for live parts <ul style="list-style-type: none"> <li>— at the side</li> </ul> </li> </ul>	6 mm
	6 mm

### Connections/Terminals





<b>Type of electrical connection</b>	
<ul style="list-style-type: none"> <li>• for main current circuit</li> <li>• for auxiliary and control current circuit</li> </ul>	screw-type terminals screw-type terminals
<b>Type of connectable conductor cross-sections</b>	
<ul style="list-style-type: none"> <li>• for main contacts <ul style="list-style-type: none"> <li>— solid</li> <li>— single or multi-stranded</li> <li>— finely stranded with core end processing</li> </ul> </li> <li>• at AWG conductors for main contacts</li> </ul>	2x (1 ... 2.5 mm <sup>2</sup> ), 2x (2.5 ... 10 mm <sup>2</sup> ) 2x (1 ... 2,5 mm <sup>2</sup> ), 2x (2,5 ... 10 mm <sup>2</sup> ) 2x (1 ... 2.5 mm <sup>2</sup> ), 2x (2.5 ... 6 mm <sup>2</sup> ), 1x 10 mm <sup>2</sup> 2x (16 ... 12), 2x (14 ... 8)
<b>Type of connectable conductor cross-sections</b>	
<ul style="list-style-type: none"> <li>• for auxiliary contacts <ul style="list-style-type: none"> <li>— single or multi-stranded</li> <li>— finely stranded with core end processing</li> </ul> </li> <li>• at AWG conductors for auxiliary contacts</li> </ul>	2x (0,5 ... 1,5 mm <sup>2</sup> ), 2x (0,75 ... 2,5 mm <sup>2</sup> ) 2x (0.5 ... 1.5 mm <sup>2</sup> ), 2x (0.75 ... 2.5 mm <sup>2</sup> ) 2x (20 ... 16), 2x (18 ... 14)



### Safety related data







<b>B10 value</b>	
<ul style="list-style-type: none"> <li>• with high demand rate acc. to SN 31920</li> </ul>	1 000 000
<b>Proportion of dangerous failures</b>	
<ul style="list-style-type: none"> <li>• with low demand rate acc. to SN 31920</li> <li>• with high demand rate acc. to SN 31920</li> </ul>	40 % 73 %
<b>Failure rate [FIT]</b>	
<ul style="list-style-type: none"> <li>• with low demand rate acc. to SN 31920</li> </ul>	100 FIT

Product function	Yes
• Mirror contact acc. to IEC 60947-4-1	
T1 value for proof test interval or service life acc. to IEC 61508	20 y
Protection against electrical shock	finger-safe

### Certificates/approvals

General Product Approval				EMC	
			<a href="#">KC</a>		
CCC	CSA	UL			C-Tick

Functional Safety/Safety of Machinery	Declaration of Conformity	Test Certificates			Shipping Approval
<a href="#">Type Examination</a>		<a href="#">Type Test Certificates/Test Report</a>	<a href="#">Special Test Certificate</a>	<a href="#">Miscellaneous</a>	
	EG-Konf.				ABS

Shipping Approval					
					
BUREAU VERITAS	GL	LRS	PRS	RINA	RMRS

other	Railway	
<a href="#">Confirmation</a>	<a href="#">Environmental Confirmations</a>	<a href="#">Vibration and Shock</a>
		
	VDE	

### Further information

#### Information- and Downloadcenter (Catalogs, Brochures,...)

<http://www.siemens.com/industrial-controls/catalogs>

#### Industry Mall (Online ordering system)

<https://mall.industry.siemens.com/mall/en/en/Catalog/product?mlfb=3RT2025-1BB40-0CC0>

#### Cax online generator

<http://support.automation.siemens.com/WW/CAXorder/default.aspx?lang=en&mlfb=3RT2025-1BB40-0CC0>

#### Service&Support (Manuals, Certificates, Characteristics, FAQs,...)

<https://support.industry.siemens.com/cs/ww/en/ps/3RT2025-1BB40-0CC0>

#### Image database (product images, 2D dimension drawings, 3D models, device circuit diagrams, EPLAN macros, ...)

[http://www.automation.siemens.com/bilddb/cax\\_de.aspx?mlfb=3RT2025-1BB40-0CC0&lang=en](http://www.automation.siemens.com/bilddb/cax_de.aspx?mlfb=3RT2025-1BB40-0CC0&lang=en)

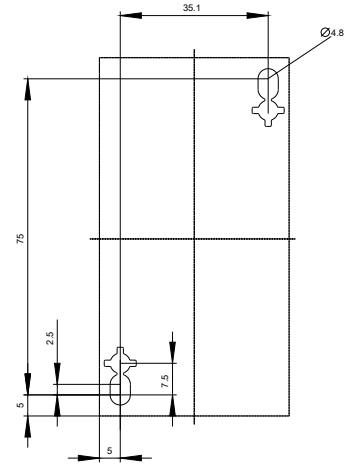
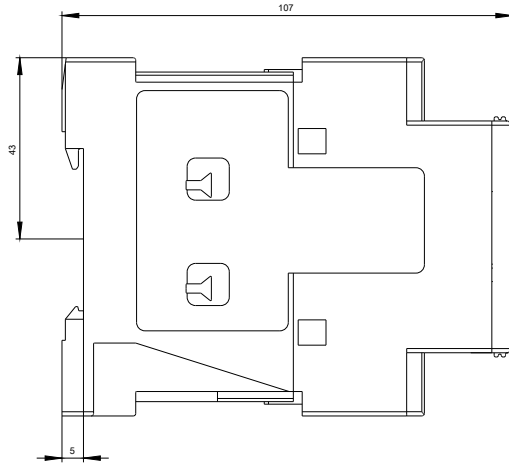
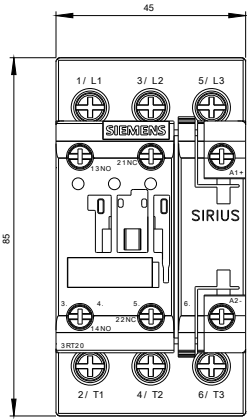



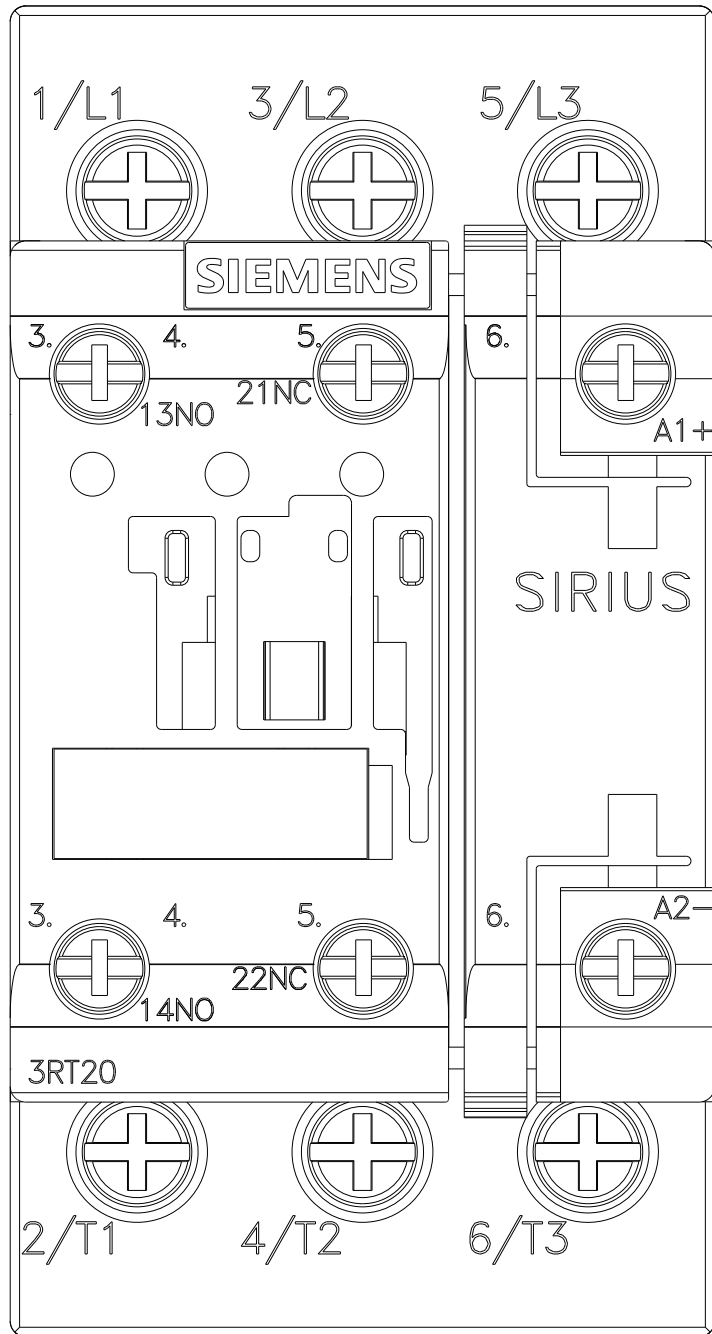

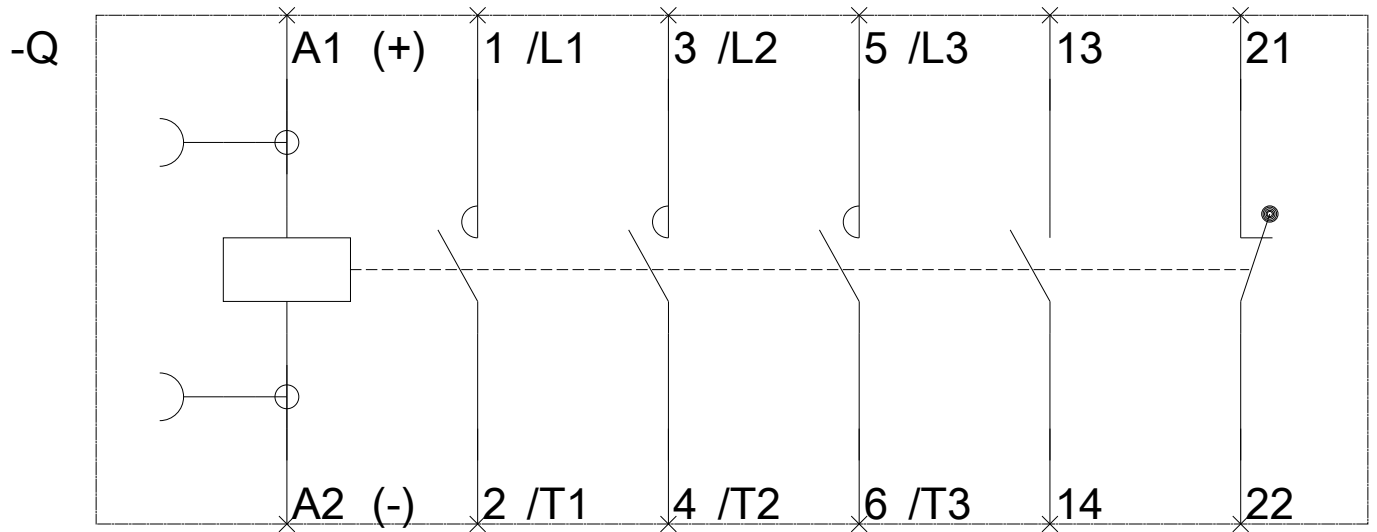

last modified:

06/20/2017